

NutriDose1

Installation and user guide

Hydroponic Nutrient Doser

**Ideal for:-
Recirculating (NFT)
Flood-drain
Drip irrigation**

KEY FEATURES

- **SIMPLE TO OPERATE**
- **Measures Conductivity, pH, Temperature**
- **Displays EC, CF, TDS, °C, °F, pH**
- **Optional PC communications to Compugrow software**
- **Direct drive dosing valves or pumps**
- **Irrigation with solar integrator and day/night times (Opt)**
- **Day/Night EC levels (Option)**
- **Water level control – to lower EC**

Autogrow Systems Ltd
www.autogrow.com

Contents

- A Introduction (all users should read this first)**
- B PC software - settings**
- C Settings for simple 1 or 2 part doser**
- D Installation**
- E Maintenance**
- F Fault finding**
- G Warranty**

Section A - Introduction to the NutriDose1 Hydroponic doser

The NutriDose1 hydroponic doser is one of the most user friendly commercial dosers on the market. It has a range of possible applications which we will discuss briefly in this section. In order to keep the user interface as simple as possible, only the readings and settings relevant to the selected features are displayed on the controllers LCD and on the PC computer. To add extra features you have to select them by going into the configure menus on either the controller or the PC (optional).

Features

A full specification is attached as appendix 1. Here we will review the features available to you. Remember, to enable any feature mentioned here you will need to go into the configuration menus on either the controller or PC to select them. When the controller is supplied it is set up as a simple two-part nutrient plus pH lower, timed dosing controller.

Selection of units

You may select either EC, CF or TDS (ppm) units for the nutrient strength and either degrees C or degrees F for temperature. The acidity or alkalinity is always measured in pH. In this manual we will use EC (electrical conductivity) to denote ether EC, CF or TDS. The date format is selectable between mm/dd/yy and dd/mm/yy formats. (The TDS standard used for this controller is EC x 500 although it is possible to calibrate it to the EC x 700 standard)

Mixing nutrients - IMPORTANT

When using any automatic doser it is important that the nutrients and acid/alkali are very dilute. The instructions on many dry powdered nutrients tell you to prepare the stock solutions to quite a concentrated level (100:1 or more). Liquid nutrients are also very concentrated. For a small mixing tank this will be too strong and even if very short doses are given the system will overshoot. If using powdered nutrient and you have a small tank, mix the nutrients into water so that for each 1Kg of powder you obtain at least 20ltrs of solution. Liquid nutrients should be diluted with water to make up about 5 times their original volume. Acids and alkalis should be diluted to be less than 2% (if you wish to use stronger acids then ensure that the dosing equipment and hoses are suitable for stronger mixes. In any event we do not recommend exceeding 5% as to avoid chemical reactions at the point of entry of the acid/alkali). (If using strong acids, always wear goggles, gloves and **add the acid to the water** then stir well). When you have the dilution right you should get a 0.1 mS/cm change in EC when you add around 25ml of A and B stock solutions. In a similar way, the pH should change by about 0.1pH or less when 25mL of stock pH solution is added. If the changes are less than this – that is fine but if it changes by more then you will need to dilute the stock solution further.

One part or two part dosing.

For one part dosing only one dosing solenoid valve or pump is used to add nutrient to the mixing tank. When two part dosing is selected then two dosing valves/pumps will be used to add part A and part B stock solutions. In this case it is sometimes found that the part A and part B do not dose at exactly the same rates (one tank empties quicker than the other).

There are a number of reasons why this may occur including different pipe arrangements, filters partly blocked, tanks or dosing valves mounted at different heights and even the fact that the two solutions may have different specific densities. To compensate for this you may adjust the two dose rates electronically by reducing either A or B dose rates below 100%. For example if you set A at 100% and B at 95% then B will dose a little less than A each time that a dose is added to the tank. This is set by trial-and-error starting with both A and B at 100%. (Always leave one at 100% and reduce the other)

Sequential dosing (default ON)

This causes the dosing pumps or valves to activate in sequence, one after the other and allows high current valves or pumps are connected to the unit without fear of overloading the controller or it's power adapter. **If in doubt** about the current required to drive the pumps then **always select sequential dosing**.

Different EC for day and night

This feature is useful for crops that need a weaker solution at certain times of the day. (eg to help prevent tip burn in lettuce) The user can define two time periods, nominally "day" and "night". For each period, a separate EC can be set. Note that this controller is able to both strengthen the mixture (by dosing) and weaken the mixture (by adding water).

Automatic addition of water (uses the AUX output)

By installing a mixing tank (reservoir tank) with two water-level float valves, one at a low level and the other at a high level it is possible for the controller to dilute the nutrient tank by adding water. This is done by operating a solenoid valve in line with the high level valve. See diagram later in the installation section.

Irrigation(uses the AUX output)

This allows a pump to be switched on periodically for a set time to irrigate plants in pots or bags. The irrigation can be specified to operate in the "day only" mode or it can have a different interval set for day and night. For example you could set it to irrigate for 4 minutes every 1 hours 35 minutes during the day and for 4 minutes every 5 hours at night. (or not at all during the night). More usually, the day irrigations will be triggered by a solar integrator. This automatically adjusts the irrigation interval to suit the weather conditions. Note that although the solar integrator is built-in to the controller, an optional solar sensor is required to enable this to operate.

Fail safe dosing

Dosing may be inhibited if any of the following is detected.

- EC probe failure or EC zero measured
- pH outside limits

Alarms

The alarms can be enabled to operate on the controller (buzzer) and if the optional PC interface is fitted, an alarm will sound at the PC via its sound card and the PC can even make a telephone call via the PC modem. Any enabled alarm will sound when either the EC, pH or temperature deviates outside user set limits. There are also a set of "voltage free" contacts on the controller to allow a low voltage siren, flashing light or autodialler to be connected.

Outputs

The outputs voltages for dosing and irrigation control are all dependent on the power supply adapter used. This makes the unit ideal to retrofit into any existing system. If the existing

pumps or relays require say 24V AC then you simply supply the controller from a 24V AC transformer. Any voltage from 12V to 24V AC or DC may be used. The unit is normally supplied with a 24V DC adapter.

PC interface

The optional PC interface allows all readings to be viewed, all settings to be viewed and changed and it also logs the measured data to disk for display in graphical form. This is very useful for identifying problems and is very useful when requesting assistance with setup. In addition, alarms can be set to sound at the PC or the PC can even dial out to a cell phone or pager. If remote access software is installed (eg PCanywhere) then all of the PC functions will be available from a remote location.

Power supply

The controller requires a power supply between 12V and 24V either AC or DC. Whatever power is applied will appear at the outputs (when they are ON). The default power adapter included with this controller is compatible with the solenoid valves or pumps supplied.

Note that the outputs are limited to a current of 2Amp load. The power supply should be sized according to the maximum load that can be applied at any one time. The maximum total draw at any one time should not exceed 4A.

Normally we supply a 24V DC 2.5Amp power supply but this could be changed in the future.

How to use this manual

The NutriDose1 has a number of modes of operation and so we have divided this manual into sections, each of which represents a particular feature. Please start by reading section C which gives basic setting information for the one or two part nutrient doser and then refer to the chapters that cover features that you require.

For installation advice, go to the installation section at the back of this manual.

Getting Started.

Follow the installation instructions in the installation section and when everything is installed and connected up do the following.

Switch on the power. Check that the power light on the front panel is on and that the LCD display has some information on it. Install the software on your PC's hard drive. To do this, follow the instruction in section I of this manual.

Section B – Setting from PC software overview

Configuration

The configuration settings are shown below and as you will see, most are self-explanatory. In the first group you can select the units that you prefer. These include TDS (ppm) which is based on the 500ppm = 1 EC standard. Of course it can be re-calibrated to any standard that you wish.

Next comes the dawn and dusk time settings. These are only needed if you select “Irrigate during day only” or “different EC for day/ night”. The times entered here do not have to align with the actual day time and for indoor growing they will be set to reflect the period that the lights are on. After changing any settings you must click the save button at the bottom to send them to the controller.

CompuGrow 2.5221 - (01) Demo : ND1 (disabled)

System Device History Refresh Setup Print Help Exit

Status History Configure

Units

EC CF EC TDS

Temperature °C °F

Date Format dd/mm/yy mm/dd/yy

Times

Dawn 07:12 a.m. Dusk 06:24 p.m.

Functions

Different EC for day and night Use water to reduce EC

Irrigation Trigger by solar integration

Irrigate during day only

Advanced

Dosing method Sequential (recommended) Simultaneous

Disable EC dosing if measured EC is less than 0.1 or greater than 6

Disable pH dosing if measured pH is less than 4.5 or greater than 8

Maintenance reminder frequency weekly 2 weeks 3 weeks 4 weeks

Save Cancel

Changes Pending...press Save when Done

The next box - “functions” required some explanation.

“Different EC day/night”. In warmer weather plants can have calcium translocation problems. In lettuce this manifests itself as “tip burn” and in tomatoes and capsicums as “blossom end rot”. Some growers find that these problems can be lessened by reducing the EC in the morning before the heat of the day – an alternative theory suggests lowering the EC in the evening. This allows the nutrients, including calcium, to be taken up by the plant before the leaves start excessive transpiration in which they take most of the rising sap and deprive other parts of the plant of calcium. Note that this controller can also be used with a “high level water” control in order to lower the EC by adding extra water as the hot part of the day approaches. This is achieved by checking the “Use water to reduce EC” check box and setting a lower EC for the day period.

“Irrigation enable” check box allows Irrigation to be enabled. When selected it will also allow you to choose if you want the irrigation to be triggered by solar integration. Solar integration automatically adjusts the day time waterings according to the weather so that in bright weather you get frequent waterings and in cloudy weather they become less frequent. Note that either irrigation OR add water may be selected but not both.

If you have a small recirculating system (eg NFT) then allowing an irrigation of outside plants every day means the solution is regularly being replaced and the usual two weekly “dumping” is then never required. You will also grow some spectacular outside plants as well. The “Irrigate during day only” check box may be used when you want to restrict irrigation to day time only. This is useful for crops grown in media which have sufficient “buffering” in the root zone to provide the small amount of water that they need at night. It avoids the media becoming water logged. In addition to this, if irrigation is permitted during the night then a separate irrigation interval is required which may be set much longer than for the day. For example, you could set the day interval to have an irrigation every 45 minutes during the day but at night this could be set to every 6 hours.

The Advanced box allows you to change the dosing method from sequential to simultaneous. By selecting sequential dosing, the dosing outputs will operate in sequence, one after the other. This allows a small power supply to be used with dosing devices that draw a heavy current. For example, small peristaltic pumps typically draw 1.5 Amps or so at 24V DC. If two part dosing was used and two pumps were allowed to come on at the same time the power supply would need to be rated at about 3Amps. By selecting sequential dosing a 2.5Amp supply can be used. Always leave it on sequential unless you have a good reason for wanting simultaneous and if you do select simultaneous you must carefully check that the total current draw is not excessive for the controller or the power supply.

In Advanced you may also disable the fail-safe dosing inhibits and select the interval that you wish to have maintenance reminders. Note that maintenance reminders cannot be disabled.

Status (and settings) tab

This screen allows you to view readings and settings for functions that have been enabled in the configuration menu.

Below is shown a typical setup for a system with most aspects enabled.

The first block shows the current readings together with their alarm minima and maxima. The alarm enables allows the alarm to be turned on or off and the detent time helps avoid false triggering as the fault condition has to be present for the full time specified.

In the next block, dosing can be enabled, disabled or forced on. Note that when forced on, the function will perform a normal operation for its normal time and then stop automatically. The “Nutrient Doses Today” keeps a count of the number of doses since midnight.

The “set-point” section is self explanatory and typical settings are shown above. This controller has been set to have a higher EC during the night than during the day.

CompuGrow 2.5221 - (01) Demo : ND1 (disabled)

System Device History Refresh Setup Print Help Exit

Status History Configure

Nutrient

EC	pH	Temp °C	Alarm
0	0	0	
Min: 0.1 Max: 0.3 Alarm: <input checked="" type="checkbox"/>	Min: 5.1 Max: 6.8 Alarm: <input checked="" type="checkbox"/>	Min: 10 Max: 30 Alarm: <input checked="" type="checkbox"/>	Detent: 1 mins

Status

Function	Enabled	Active	Force On
Nutrient dosing	<input checked="" type="checkbox"/>	<input type="button" value="No"/>	<input type="checkbox"/>
pH Dosing	<input checked="" type="checkbox"/>	<input type="button" value="No"/>	<input type="checkbox"/>
Irrigation	<input checked="" type="checkbox"/>	<input type="button" value="No"/>	<input type="checkbox"/>

Nutrient Doses Today:

Set Points

Parameter	Day	Night
Nutrient (mS/cm)	<input type="text" value="1.1"/>	<input type="text" value="1.8"/>
pH	<input type="text" value="5.8"/>	<input type="button" value="Raise"/> <input type="button" value="Lower"/>

General

Nutrient dose time	<input type="text" value="8"/> secs
pH dose time	<input type="text" value="3"/> secs
Dose interval	<input type="text" value="2"/> mins
Mix	A: <input type="text" value="100"/> % B: <input type="text" value="95"/> %
Irrigation duration	<input type="text" value="00:01:30"/>
Irrigation interval time	Day: <input type="text" value="0"/> Days <input type="text" value="3"/> hrs <input type="text" value="35"/> mins Night: <input type="text" value="5"/> hrs <input type="text" value="0"/> mins
Solar	<input type="text" value="0"/> J/m2/sec SolarToday: <input type="text" value="0"/> MJ/m2
Trigger	<input type="text" value="1.23"/> MJ/m2 Solar integration count: <input type="text" value="0.81"/> MJ/m2

Save Cancel

Demo Mode

General section - Dose and dose interval timings.

The dose times should be set so that each dose changes the measured value by about 0.1EC (1CF or 50ppm) every time it doses. This means that at the last dose the maximum overshoot will be of this order. Similarly, for pH, each dose should change the measured reading by about 0.1pH.

The dose interval should be set so that after each dose, the reading stabilises to its new value in this time. Note that when a dose first occurs it is usual for the EC to rise above the setpoint and then gradually settle as the stock solution mixes in.

If the dose time is set to zero seconds then the dosing will be continuous ie the valves/pumps will come on if the reading is below the setpoint and stay on until the reading passes the setpoint. A dose time setting of zero should be avoided unless you have a specific need for this (eg continuous dosing whilst irrigating and filling)

The percentages for A and B are translated into dose times automatically by the controller with 100% corresponding to the set dose time, 50% to half the set dose time etc. Be careful not to set very small percentages with short dose times as these might translate into a dose time that is too short for the valve or pump to operate. Normally 2 seconds is about the minimum time for a valve and 3 seconds for a pump.

Irrigation intervals and durations for day and night are also set here as is the water ON time for each addition of water. This should be set so that each time it adds water it dilutes the nutrient by about 0.2EC (2CF or 100ppm).

Calibration

Note that Calibration of the sensors (EC and pH) can only be done from the controller and this must be done before using the system.

Saving your settings to the PC

A copy of all the settings in the controller can be uploaded and saved to PC's hard disk. When this is done you have the option of renaming the file allowing you to create files for "summer", "winter", "Lettuce", "Herbs_summer" etc. These settings can then be instantly downloaded to the controller on the change of crop, season or if ever you swapped out the controller.

To save settings, go to "setup" on the top menu bar, then to "detailed device" and select either save settings or restore settings.

The "diagnostic mode" in the "detailed device" sub menu is useful for your hort consultant, supplier or Autogrow Systems for diagnosing problems. This allows you to email a copy of your settings and log files to the consultant and by going into diagnostic mode they will be able to "restore settings" into their PC and view your settings and logs.

History Screen

The logged data can be viewed over a wide range of time scales. This example shows it viewed over a period of 3 days starting from 18:00 on the 16 July 2006. You can clearly see when doses occur and also the swing in nutrient temperature between night and day time

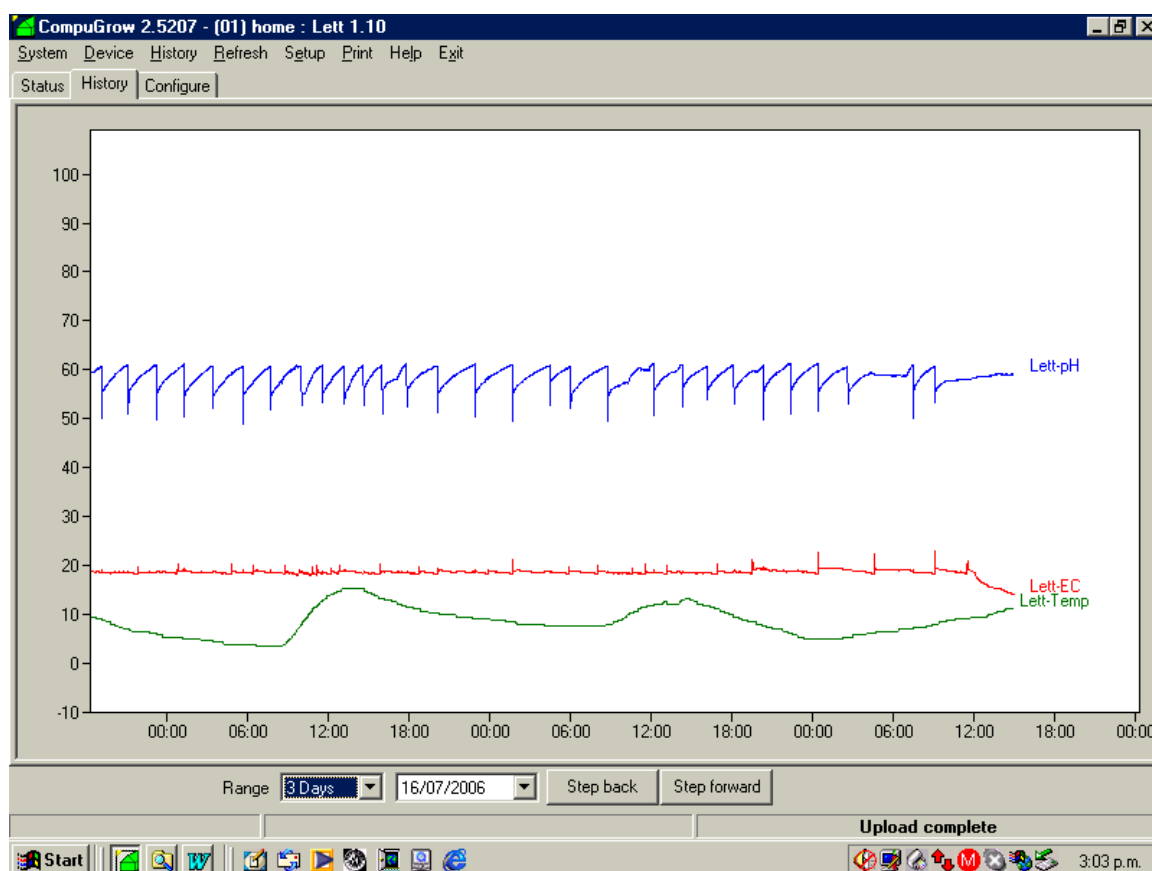

Setting from the controller LCD and push buttons.

If you can use a cell phone you should have little difficulty in setting the controller from its LCD and keypad as they operate in a similar manner to modern phones.

From the “home” or “default” screen if you select “menu” you will see the main menu. Press the up and down arrows to traverse the main menu until you reach an item of interest. Then press “enter” to enter the sub-menu for that item. Again press the up and down keys until you find an item of interest and the press enter again. Eventually you will enter a screen where a setting can be altered. Now press the up arrow to increase its value and the down arrow to decrease it. Finally, press save to save it or press cancel if you don’t want to save it.

The items in the greyed boxes are only visible if the conditions in the right hand column are satisfied. So, for example, the EC day and night setpoint screens will only appear if you have selected different EC for day and night in the “Configure” sub-menu. This helps to keep the user interface as simple as possible.

For advice on any particular setting please read the comments in the previous section

LCD Menu and sub-menus

MAIN MENU	SUB-MENU	ONLY VISIBLE IF:-
Dose - EC & pH Dosing Settings	EC/ph - Enable/Disable EC/pH Dosing (Enable/Disable)	
	EC setpoint (xx.x)	(If EC Day/Night same)
	EC day setpoint (xx.x)	(If EC Day/Night not same)
	EC night setpoint (xx.x)	(If EC Day/Night not same)
	pH setpoint (xx.x)	
	pH mode - Raise = Alkali, Lower = Acid (Raise/Lower)	
	EC Dose Time (xx seconds)	
	pH Dose Time (xx seconds)	
	Dosing Interval (xx Minutes)	
	Water - Enable/Disable Water Dosing (Enable/Disable)	(If Aux Water)
Water Dose Time (xx Seconds)	(If Aux Water)	
Irrigation - Irrigation Settings	Irrigation - Enable/Disable Irrigation (Enable/Disable)	(If Aux Irrigation)
	Irrigation Run Time (x:xx:xx (Hrs:Mins:Secs))	
	Irrigate Every - Daytime Irrigation Interval (x:xx:xx (Hrs:Mins:Secs))	
	Irrigate Every - Nighttime Irrigation Interval (x:xx:xx (Hrs:Mins:Secs))	
	Irrigate during (Day & Night/Day Only)	
	Solar Trigger - Enable/Disable Solar Triger (Enable/Disable)	
	Solar Intergration - Solar Intergration (xx.xx MJ)	
	Solar Trigger - Solar Intergration Trigger (xx.xx MJ)	
	Sir Cycle - Enable/Disable Stir Cycle (Enable/Disable)	
	Stir Run Time (x:xx:xx (Hrs:Mins:Secs))	
Overrides - Manual Overrides	Force EC - Press <Force> to Action	
	Force pH Lower - Press <Force> to Action	
	Force pH raise - Press <Force> to Action	
	Force Irrigation - Press <Force> to Action	(If Aux Irrigation)
	Force Water - Press <Force> to Action	(If Aux Water)
Calibration - EC & pH Calibration	pH Calibration - Press <Enter> to Start EC Calibration	
	EC Calibration - Press <Enter> to Start pH Calibration	
Alarms - Alarm Settings	Hold off Time - Delay before activating Alarm (x Minutes)	
	EC Alarm - Enable/Disable EC Alarm (Enable/Disable)	
	Min EC - Alarm when EC under (xx.x)	
	Max EC - Alarm when EC over (xx.x)	
	pH Alarm - Enable/Disable pH Alarm (Enable/Disable)	
	Min pH - Alarm when pH under (xx.x)	
	Max pH - Alarm when pH over (xx.x)	
	Temp Alarm - Enable/Disable Temp Alarm (Enable/Disable)	
	Min Temp - Alarm when Temp under (xx.x)	
Max Temp - Alarm When Temp over (xx.x)		
Clock - Time @ Date Settings	Day Start (Dawn) - Start of light Period (xx:xx)	
	Day End (Dusk) - End of Light Period (xx:xx)	
	Minutes (xx)	
	Hours (xx)	
	Date (xx)	
	Year (xx)	
Configure - Units & System	Nutrient Unit (EC/CF/TDS)	
	Temperature Unit (C/F)	
	Dosing Mode (Sequential/Simultaneous)	
	Day/Night EC - Diff EC for Day & Night (Same/Different)	
	EC Range Lockout - Lockout if EC<0.1 or EC>6.0 (Enable/Disable)	
	pH Range Lockout - Lockout if pH<4.5 (Enable/Disable)	
	Part A Dose% - Percentage of EC Dose time (xxx%)	
	Part B Dose% - Percentage of EC Dose time (xxx%)	
	Aux Output (Disabled/Irrigate/Water)	
	Buzzer Allowed (Allowed/Muted)	
	Address (xx)	(If PC comms module fitted)
	Screen Contrast (xx)	
	Technician Report - Numerically Encoded	

Section C - Simple one or two part doser

In the Configure menu on the NutriDose1 or the Configure tab on the PC select the units that you wish to use and then select one or two part dosing.

To set manually

- 1) Calibrate the EC and pH sensors as described below. This can only be done from the controller keypad.
- 2) In “configure” select the units you wish to work in, choose whether you want a different EC for day and night and ensure sequential dosing is selected.
- 3) In the Dose sub-menu set the desired EC, pH and choose pH raise or pH lower
- 4) In Dosing settings set the EC dose time. This should be set so that each dose raises the EC by about 0.1mS/cm (1CF or 50ppm)
- 5) In Dosing set the pH dose time so that each dose alters the pH by about 0.1pH
- 6) In Dosing settings select either pH raise or pH lower. The most usual selection is pH lower (acid dosing) and if you are unsure then select this. If you find that the pH continually drifts down below 5.5pH then change this to pH raise and ensure that you have a dosing valve or pump connected the pH raise output and to a stock tank containing pH raise (alkali)
- 7) In Dosing settings set the dose interval. This is the time taken for each dose to mix in and for the EC and pH readings to stabilise. For a small system, 2 or 3 minutes is typical. Larger systems may require 10minutes or more.

To Calibrate EC sensor

- 1) Clean the face of the probe. Remove the shroud from the end of the probe and use a little kitchen liquid scouring cleaner such as “Jif” on a **clean** cloth or occasionally use a little Jif on a “Scotchbrite” nylon scouring pad. Do not use the scouring pad too often as it will gradually erode the face of the probe. Use a circular motion to scour the face of the probe and then rinse well in running water. Do not touch the face of the probe but shake off any residual water.
- 2) Replace the shroud and then place in the calibrating solution. The solution supplied has an EC of 2.77mS/cm at 25°C (CF=27.7, ppm = 1382). Allow about 5 minutes for the temperature compensation to fully kick-in and then press the menu button to get down to the Calibrate screen. Then press “Enter” to get to the Calibrate sub-menu where you will again press menu to step through this sub menu until you reach the “Calibrate EC” screen. Then press “Enter” again, to get into the “Calibrate EC screen”. Now press either the UP or Down arrow keys to get the calibrated reading to correspond with the Standard calibrating solution (normally 2.77mS/cm, 27.7CF or 1382ppm). When this is achieved, press the save button to save this in permanent memory.

Calibrate pH sensor

- 1) If necessary, clean the glass bulb at the tip of the sensor with a very soft “child’s” toothbrush or a special cleaning tool with a little liquid scouring agent such as “Jif”.
- 2) Rinse thoroughly in water and then place in the pH 7 buffer solution. NOTE THAT YOU MUST **ALWAYS** CALIBRATE AT pH 7 **BEFORE** pH4.
- 3) Allow a few minutes for the reading to stabilise and then press the menu button to reach the Calibration screen. Press Enter to get into the Calibration sub-menu and then “Enter” the Calibrate pH 7 screen. Now press the up and down arrows until the reading exactly matches the calibration solution (eg pH 7.0). Press “Save” to store the calibration.
- 4) Rinse the probe and place in pH 4 buffer solution. Allow to stand for a few minutes until there is no further change in the pH reading. Now use the Menu and Enter keys to navigate to the Calibrate pH 4 screen. Press the up and down arrows to get the calibrated reading to match the calibration solution and then press “Save” to save the calibration and exit from that screen.

The EC probe should be cleaned regularly – every 2 weeks and all calibrations checked. In addition it is advisable to use a hand held meter to check the EC and pH every day. If ever the hand held instrument and controller readings differ significantly then all probes should be cleaned, checked and recalibrated.

Section D - Installation

Mount the NutriDose1 controller within 1.5 metres of the sample pot but in a position well away from water splashes or mist/vapour rising from the reservoir tank or stock tanks (especially acid fumes). It should be mounted in a **cool, dry place out of direct sunlight**. Screw firmly to a panel on the wall.

Typical installation using peristaltic pumps

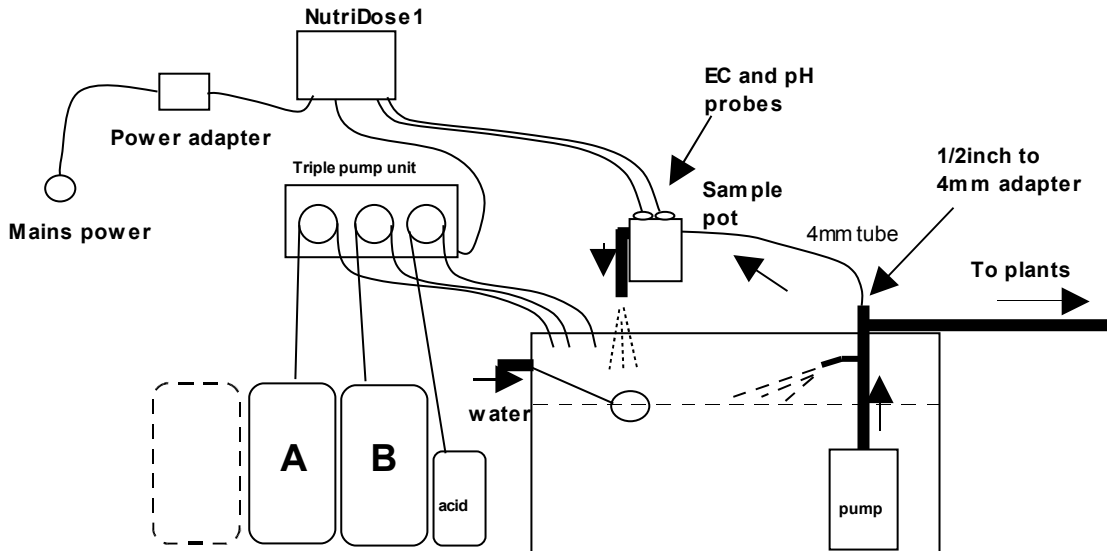

HINT:

- (1) *Keep sample pot low down just above top of tank as many small pumps have quite low head pressure capability*
- (2) *Mount NutriDose1 away from spray and humidity from tank and stock solutions*

Typical installation using solenoid valves

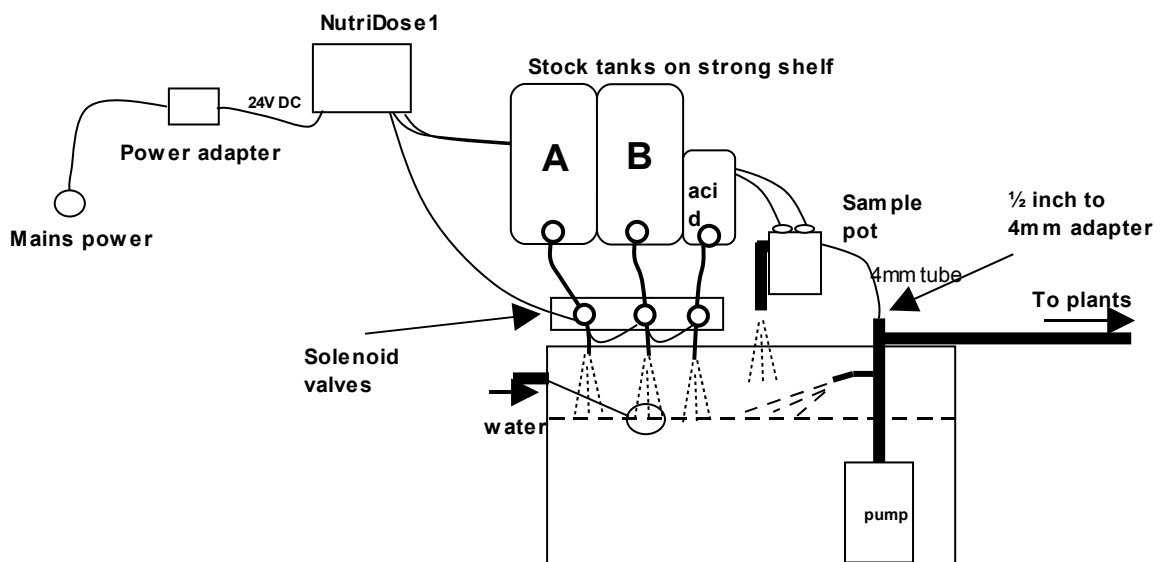

Note that a small jet of water may be directed over the surface of the tank to stir and aerate the nutrient solution. This can be achieved by heating and squeezing with pliers an outlet from a Tee fitting. Ensure that your pump has sufficient excess capacity before doing this.

Layout showing use of high and low water levels

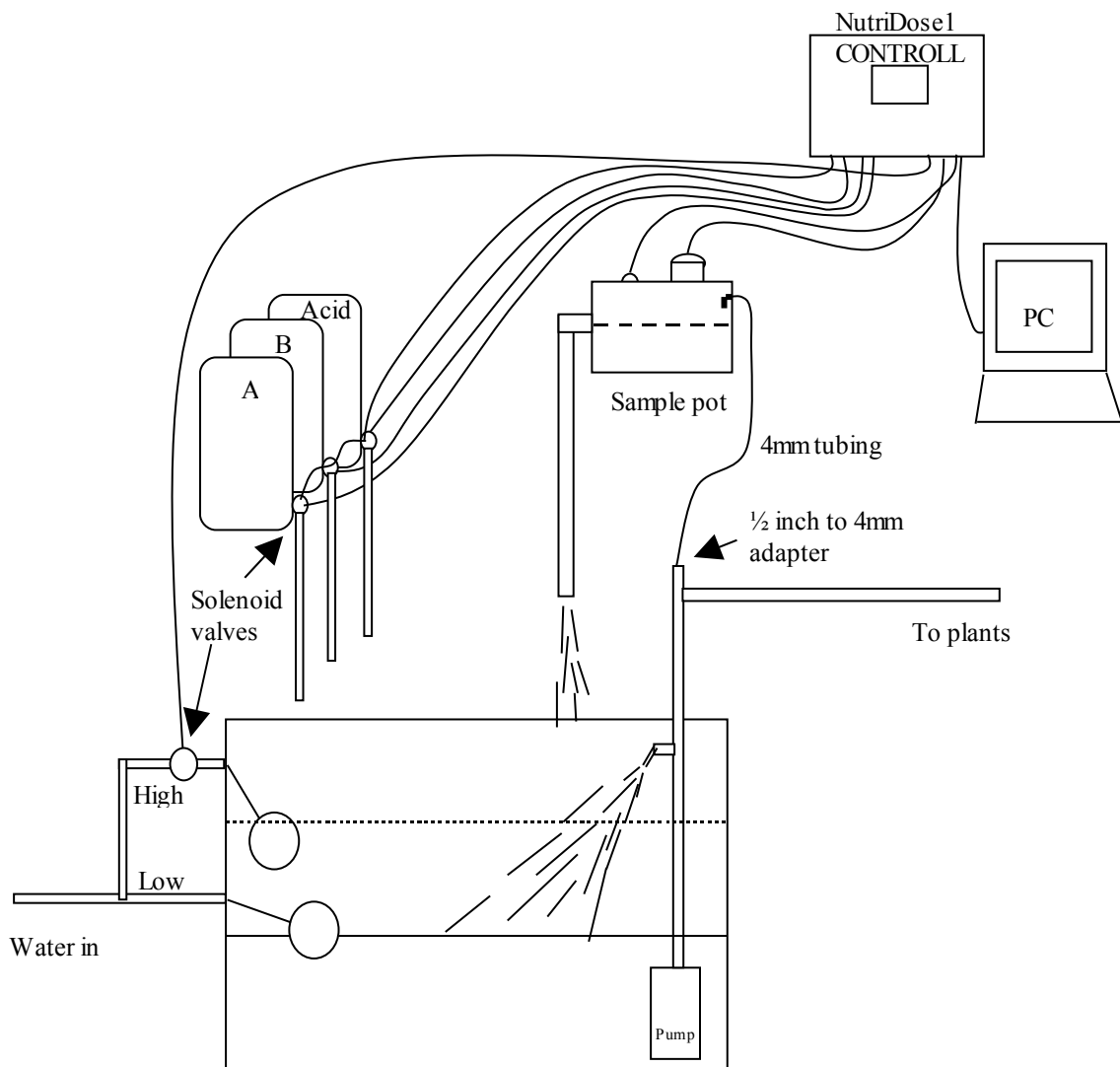

NOTES:

- 1) If irrigation is used then a second small pump should be used to continuously circulate the solution through the sample pot and keep the tank stirred. The irrigation pump would then need a “pump start relay” with a 24V DC coil (If a power supply other than 24V DC is used then the coil voltage and current type must match the power supply) to switch it on only when an irrigation is called for.
- 2) If the irrigation water is returned to the reservoir tank then allowance must be made for the level to rise a little above the float valve level. For example, in a flood-drain system the float valve must be mounted low in the tank to allow space for the drain water to return after each “flood”.

The power supply to the NutriDose1 must be between 12V and 24V either AC **OR** DC. **The outputs to the solenoid valves or pumps will be the same as the supply going into the controller.** This means that if 24V AC solenoid valves or relay coils are used then the supply adapter must provide 24V AC. Never connect a power supply exceeding 24V to the controller.

The low voltage power from the adapter is connected to the two connections 7 & 8 on the lower connector. With many power supplies the cable is a screened “co-axial” type. In this case the screen should be connected to the “Common” and the centre wire to the 24V-live

connection on the controller. If using peristaltic pumps, check that these all turn clockwise (in the direction of the arrow on the cover). If not, then reverse the power connections to pin 7 & 8 of connector 1.

Solenoid valves

Connect the valves using the cable supplied to the electrical outputs as shown below. If the valves are 24V DC then the power supply should be 24V DC. If AC valves are used then a power pack that supplies 24V AC power must be used. The solenoid valves are installed as shown overleaf.

Peristaltic pumps

You can direct drive small 24V DC peristaltic pumps if you have the appropriate power supply. The small pumps available from our distributors draw a current of up to 1.2 Amps and so to run three pumps at the same time, you will need a 4 or 5A, 24V DC power supply. To avoid the necessity of such a powerful supply you may select the “Sequential dosing” option (in the configure menu). In this case, pumps are run one after the other and so at any one time there is only one pump running. A 2A, 24V DC supply is sufficient for this. We have available a 2.5A supply that allows 2 part dosing to run simultaneously.

To install solenoid valves

- 1) Thoroughly clean tanks to ensure that no plastic chippings or swarf is left in them
- 2) Use 3/8 inch tubing to connect from the stock tank outlets to the inlets of each solenoid valve
- 3) Fit the reducers to the bottom outlet of the valves and use 1/4” tubing to direct the output into the tank. The lower end of the tubing must not enter the water and all valves should have the same length of tubing to try to achieve equal dose rates.
- 4) Test with plain water first to ensure no water leaks and system operates correctly then empty and refill tanks with the stock solutions
- 5) For acids and alkalis, ensure that they are suitably diluted (2%)
- 6) Wire the solenoid valves to their respective connections on the controller as shown in the wiring diagram

NutriDose 1 connections

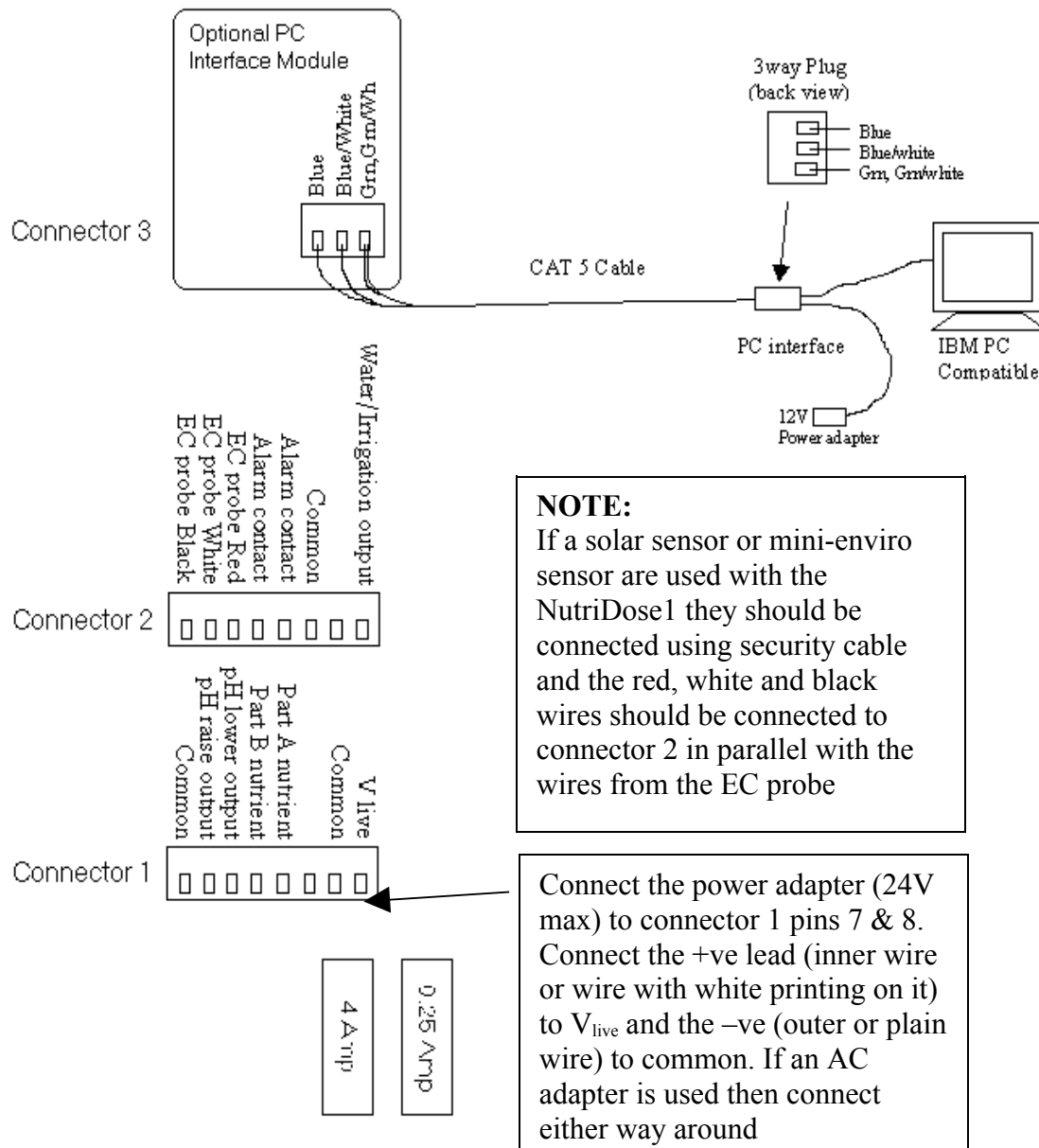

Note that all the connections marked 24V common are connected together internally and you may connect the return from any solenoid valve or pump to any of these commons

IMPORTANT

The voltage at the outputs will always be the same as the voltage from the power adapter. For peristaltic pumps this will usually be a 24V DC power adapter but for solenoid valve dosing it may be 24V DC, 24V AC or even 12V AC. In all cases, please ensure that the voltage rating of the connected device (valve or pump) matches the voltage rating of the supply.

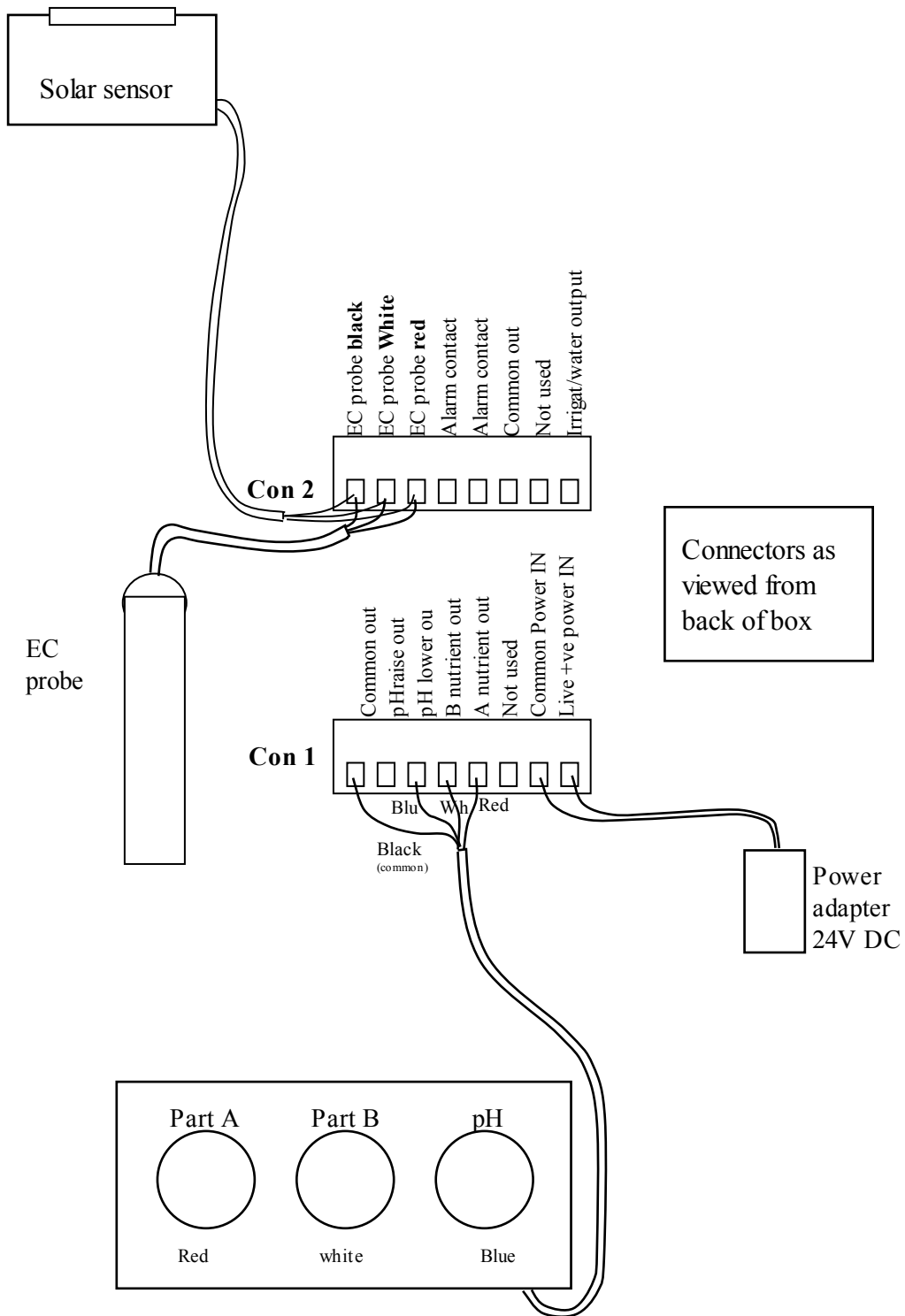

Connections for Peristaltic pump unit

Wire colors for triple pump

- Black = common (connect to any common)
- Red = left pump (eg nut A)
- White = mid pump (eg nut B)
- Blue = right pump (eg pH lower or part C)

Note that the right hand pump may alternatively be connected to Nutrient part C, pH lower or pH raise.

Irrigation output

The irrigation output on connector 2 is normally required to drive a mains powered pump. In order to do this a relay must be used. The relay coil must have a voltage rating the same as the power adapter supplying the NutriDose. The relay contact rating must be more than sufficient to carry the pump current at the rated main power voltage. An electrician will be able to obtain and connect a pump start relay safely.

Alternatively, a relay box may be obtained from our distributors to simplify this. A relay box is simply a plastic box with one or more socket outlets on it, each controlled by a relay. A flexible cord with a three pin plug supplies power to the box from a regular wall power outlet. A separate low voltage cable is used to connect between the NutriDose controller and the relay coil. In the case of a single relay box there will be a pair of wires for this purpose; connect one wire to the irrigation output on connector 2 and the other wire to a common connection point. In the case of twin relay boxes, connect the black wire to the common and use the red wire as the feed to the top relay and the white wire as the feed to the lower relay. Note that with a twin relay box the combined current draw must not exceed the total current rating marked on the front of the box.

Upgrading the NutriDose to be PC communications capable

In order for the NutriDose to communicate with a PC three things are required. First, a small circuit board must be fitted inside the NutriDose, second a PC interface box must be connected to the PC and thirdly, Compugrow software must be installed on the PC. Note that many NutriDose controllers can connect to a single PC via a single PC interface box and all will be accessed via the single Compugrow software.

To install the comms circuit board.

- 1) SWITCH OFF the power to the NutriDose
 - 2) Remove connector 2
 - 3) Remove the small Philips head screw just above connector 2
 - 4) Carefully insert the pins of the comms circuit board into the connection sockets
 - 5) Refit the screw which will hold the circuit board securely in place
 - 6) NB if the screw hole does not line up with the screw stud then the circuit board is misaligned. It should be unplugged and repositioned so that all pins enter the connectors and the screw can be easily inserted
 - 7) Connect from the three way connector on the circuit board to the three way connector on the PC interface box – see next section for connection details
- Note that this connection should be made with twisted pair data cable such as Computer network cable CAT 5. If possible use stranded CAT 5 cable in preference to the more common solid cable as the solid cable easily breaks if the cable is ever moved.

Connections to PC interface

Use light coloured (so as not to attract heat) CAT5 stranded computer network cable between the PC interface and the AutoVent and/or monitors. This cable is “looped in” to each controller/monitor in a “daisy chain” fashion. The last monitor (and only the last monitor) in the chain must have a “terminator” fitted. Remember, when adding a further controller/monitor to remove the terminators from any monitor or controller between the PC interface and the last monitor in the chain. See connection diagram below.

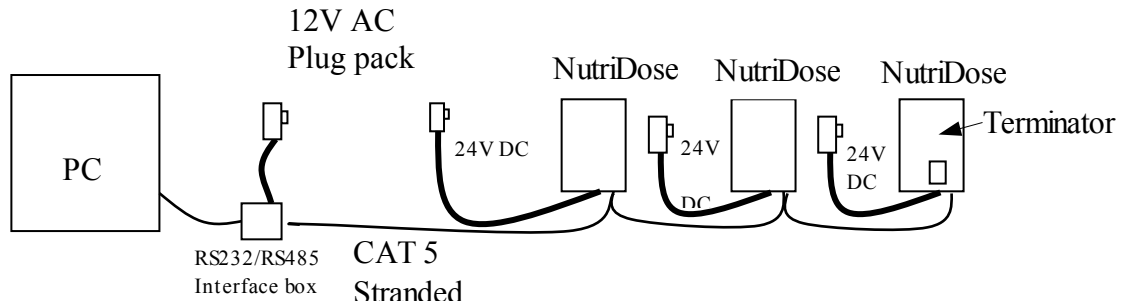

PC connection showing a single terminator at the end of the cable

Installing the PC interface

The PC interface box must be positioned close to the PC and is connected to the PC by means of a short standard serial cable. The PC interface box is powered from a small plug pack that supplies it with 9V-12V AC or DC power. The connection between the PC interface box and the first controller must be by means of a stranded CAT5 cable. See the wiring diagram in section 5.

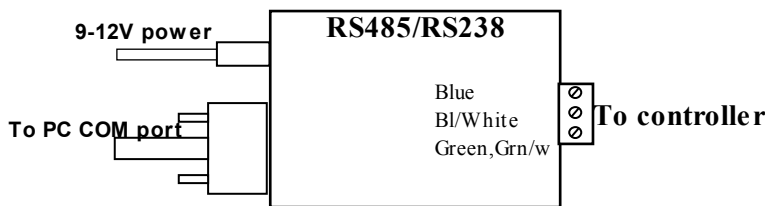

PC interface connections

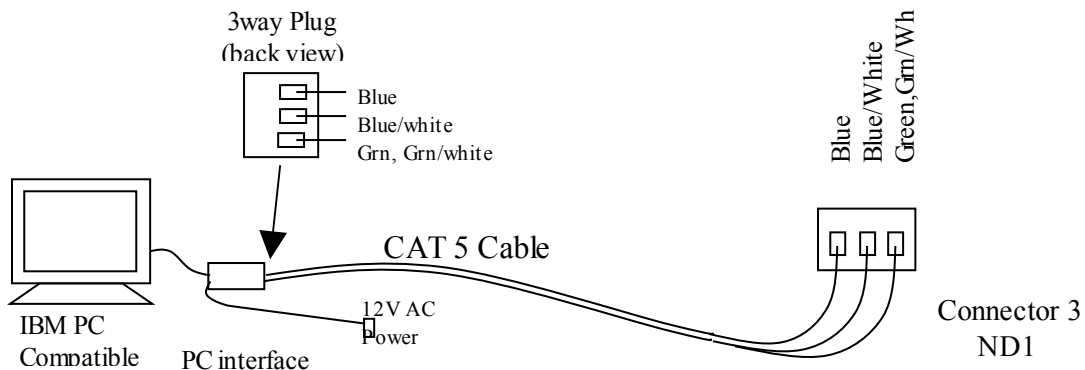

Connection of PC interface to the ND1 controller

7.4 Installation of Compugrow Software on the PC

The CompuGrow software is suitable for PC compatible computer running Windows 2000 or XP. It may also run on Windows 98 SE but the resources under W98 are limited and operation is not so reliable as with 2000 or later. The computer must have a free serial COM port and should be a Pentium or better. If the PC has no serial COM ports but has USB instead then a proprietary USB to Serial converter may be used.

To install the software on your PC, insert the disk in drive A and execute the CompuGrow install programme. This will self-install the software onto your hard drive. You will be prompted during installation to select a folder. The default folder is C:\Program Files\Compugro\ . When the program is executed it will create some sub-folders under the main folder. Each system (greenhouse group) installed will have its own sub-folder where the files for each of its monitors is stored. Each file will save the data for the whole current month.

Communication addresses. When the PC requests data from a controller or monitor it first sends the address for that unit. All units connected to the PC must have a different address and moving to SYSTEM/address sets this. The base address for these controllers is 34. Press the up or down arrows to change the address and when the required address is displayed, press save to store it in permanent memory. Set up the monitors in sequence starting with the first one at 34 and working upward from there. ie set the first monitor to 34 the second to 35 the third to 36 etc. Make a note of the address of each controller/monitor and its type as you will need to enter this information on the PC.

Terminator. If this is not the furthest controller/monitor from the PC then the terminator must be removed and the Data comms cable will be connected as shown and will then loop back out of the box and on to the next controller/monitor. Only the furthest unit should have a terminator connected. See connection diagrams above.

Configuring the PC software.

Before running the software it is best to install all the controllers and monitors. They should all have their date and time setting checked and each device must have its address set to a unique number. Remember to save the addresses after making any changes and to note these down as you will need them when installing the PC software.

Setting the comms addresses

At the controller, press the MODE button until you reach the "SYSTEM" menu item. Then press "enter" (the up arrow) to enter this sub menu. The first item in this sub menu should be "address". This is the communications address which is normally set by the factory to 34. If you have more than one controller or monitor in your system then they must all have different addresses. Just press the up and down arrows to get the addresses to be different. Although it doesn't matter what they are it makes sense to work logically with the first one set to 34 the second to 35 etc. Make a note of the addresses associated with each controller. Now, at the PC, run the compugrow.exe application and then set up as follows.

When the Compugrow software is first executed the immediate task is to select the required access level. In order to set the system up, security must either be "disabled" or else you must select 'advanced' and enter the advanced password which is 'consult'. The basic level password is 'grower'. When in advanced mode you can disable security by selecting setup/security/disable.

Next, select the serial COM port that the RS232/RS485 adaptor is connected to. (Note that the adaptor must be one supplied by Autogrow as it performs some special functions as well as converting the signal levels.)

Under “setup” select “add” to add a new system then give the system a name (usually the name of the greenhouse eg lettuce 1) also check the controller box and monitor box if you also have any monitors in the system.

The idea of having different “systems” is that in a large installation where you might have a number of controllers and/or monitors in each greenhouse, it allows you to collect together all of the devices from the one greenhouse as one system so that when you view them they are not muddled in with devices from the other houses. However, if you are only intending say one or two controllers per greenhouse then it is probably more convenient to put all devices into one system.

Once a system has been added, select setup/system setup/configure/<system name>
And for each controller and monitor, add the address (as set at the actual controller), select the type of controller, enable it and finally click on “save”.

The PC will now try to communicate with the device and values should appear on the “Readings and Settings” tab. If not, try clicking on “refresh” on the main menu bar and observe the message at the bottom, right of the screen. If this says “offline” then the communication link has failed and you will need to recheck that everything is wired correctly and switched on etc. Also recheck all settings. If still not working refer to the fault finding section.

Section E – Maintenance

Clean EC probe

Every two weeks or at least once per month, remove shroud from end of probe. Apply a little white (non scented) liquid scouring paste (eg liquid JIF) to the face of the probe and rub with a circular motion using the finger tip or a clean cloth. Rinse under running water – do not touch the face of the probe. If the probe is very dirty, use the liquid scourer on an abrasive nylon scouring pad such as ScotchBrite. Replace the shroud and check calibration.

Every year, check that the face of the probe is still perfectly flat. If it appears rounded or hollowed out (especially the graphite electrodes) then you will need to “dress” or flatten the face of the probe. Use a piece of fine grit “wet & dry” paper (available from automotive parts stores) on a flat surface. Apply plenty of water and then holding the probe vertical, rub the face, using circular motion, on the paper until any sign of hollowing has gone and the face appears perfectly flat and smooth.

Calibrating the EC probe

After cleaning and rinsing the probe, shake vigorously to remove any surplus water. Now place the probe in EC standard solution and allow the temperature compensation to take full effect by leaving for 5 minutes or more. Calibration solutions are usually 2.76mS/cm referenced to 25°C but any calibration solution may be used.

The reading should settle to within 0.1 EC (1 CF or 5ppm) of the value stated on the bottle. If not then navigate to the EC calibration screen on the controller (not available on the PC) and press the up/down arrows until the reading exactly matches the value printed on the bottle. Note that calibration solutions are easily contaminated or changed by evaporation and should be replaced with fresh solutions every 3 months or more frequently if high accuracy is required.

Cleaning the pH electrode

The glass bulb at the end of the pH electrode should be shiny and clear. If not then it may be cleaned by brushing with a soft child's toothbrush or special cleaning tool together with a little liquid scourer such as Jif or Soft Scrub. Do this very carefully as the glass bulb is extremely delicate. Rinse thoroughly with clean water.

Calibrating the pH electrode

Every week you should check the pH calibration.

To do this place the probe in the pH7 buffer solution and allow to stand for 10 minutes. The reading should be 7.0 +/- 0.1 pH. If not then navigate to the pH 7 calibration screen and use the up/down arrows to correct the displayed reading. When correct, press save.

Next rinse the probe in fresh water and shake off excess water. Now place in the pH 4 buffer solution and allow to stand for 10 minutes. The reading should be 4.0 +/- 0.1. If not navigate to the pH 4 calibration screen and use the up/down arrows to correct. Now press save to store the calibration.

IMPORTANT: The pH 7 calibration MUST be carried out before the pH 4 calibration.

pH electrodes last for between 6 months and two years. As soon as the electrode shows signs of drifting or slow response it should be cleaned and if this does not improve it's performance, it should be renewed. Do not wait for it to give totally erroneous readings.

Peristaltic pump maintenance

These require very little maintenance other than occasional greasing of the rubber tubes (using special rubber grease from the manufacturer). The grease may be applied via the two greasing access points in the clear plastic pump covers.

When the tubes become flattened they should be replaced.

Hint: it is sometimes possible to extend the life of the tube by sliding the tube around a little so that a new section of tube is exposed to the rollers. To do this, loosen the two screws in the front cover, slide tube and then retighten.

Solenoid valves

These need very little maintenance but if the flow rates of the A and B solutions becomes unequal the valves can easily be opened up for inspection and cleaning. If a valve stops working completely there is a possibility that the solenoid coil has become defective. The coils can be replaced.

General maintenance

Frequently inspect your system for leaks and repair these as soon as possible. Water dripping onto solenoids or pumps will soon cause them to fail. Ensure the controller, pump unit and solenoids are kept clean and shielded from all water splashes and vapours.

Section F - Fault finding

- 1) Unit is completely dead – ie no display, no power light and no outputs
Check that the power pack is functioning (by measuring with a voltmeter if possible) and that it is plugged in, switched on and properly connected to the controller.
Next check the fuses. The 0.25A fuse governs the power to the controller mechanism whereas the 4A fuse protects the outputs.
If either fuse is blown, replace with a genuine fuse of the correct size.
The most likely cause of the 4A fuse blowing is that wires connecting to the solenoid valves or pumps have touched together and shorted out. To fix this it is important to clear the fault first. Inspect all wiring and ensure that all wires are well insulated right to the point where they enter the connector. Also check the connections at the solenoid valves. Then replace the fuse with a genuine 4A fuse. **DO NOT ATTACH WIRE OR ALUMINIUM FOIL ACROSS IT.**
- 2) Cannot calibrate pH. Replace the pH electrode with a standard BNC gel filled electrode.
- 3) EC calibration out or EC reading varies. Ensure that there is a small non-turbulent flow of solution past the face of the EC probe. Ensure probe has been properly cleaned and is free from grease or oil. (water should easily wet the face and should not bead).
- 4) pH fails to dose. Ensure that the controller is set for raise or lower to match the solution used. ie if you are using acid (pH down) then set the controller to pH lower and ensure that that pump/solenoid is connected to the pH lower output.
- 5) pH overdoses. Check that the controller is set for pH raise or lower as described in 4 above. Also, check that the dose time is not excessive. Each dose should change the pH by about 0.1pH
- 6) EC overdoses. Check that there is adequate flow through the sample pot and that the EC dose time is not excessive. Each dose should change the EC by 0.1 (CF1 or 50ppm)

G Warranty

The warranty on the controller, EC sensor and temperature sensor is limited to 2 years – return to factory. Before returning the unit for service you must call Autogrow Systems Ltd for a return authorization .

pH sensors carry a 6 month warranty, solenoid valves and pumps carry only a 12 month warranty from their respective manufacturers. The pump squeeze tubing is a dispensable item and has no warranty.

This warranty specifically excludes any parts that have been broken or damaged by water, chemical attack or excessive temperature. In particular, the controller and power adapter must be stored and used in a dry, shaded and well ventilated situation. At no time must the case temperature be allowed to exceed 60 deg C (140 deg F).

This warranty expressly excludes liability for consequential damages or for charges for labour or other expense in making repairs or adjustments, or loss of time or inconvenience. Freight to the factory must be prepaid.